

# CHAIN REPLACEMENT - MODEL C,D,E

0607

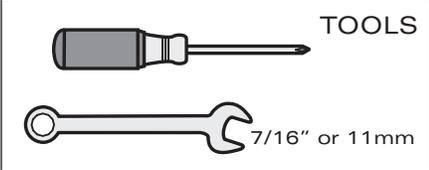

concept2.com



1.



2.

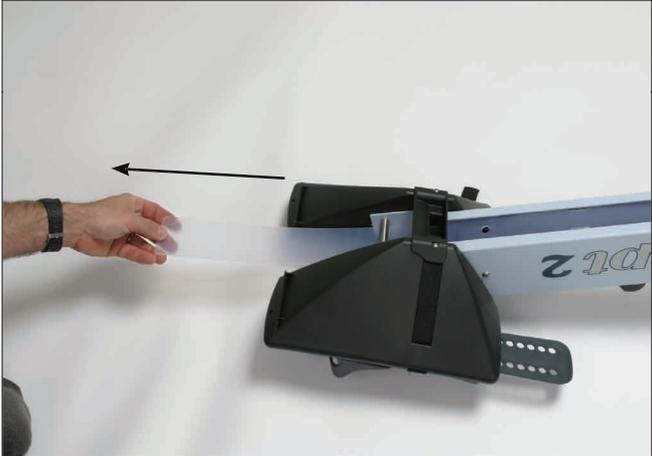

3.



4.



5.



6.



# CHAIN REPLACEMENT - MODEL C,D,E

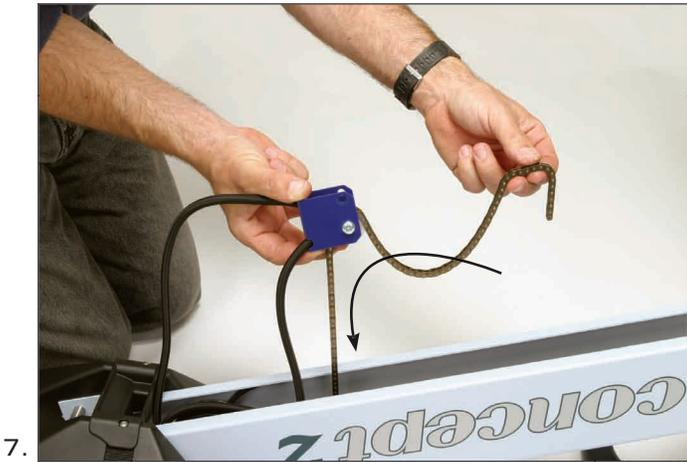

7.



8.



9.

**Note:**  
 If your rower has a wooden handle, follow steps 10-14.  
 If your rower has a plastic handle, follow steps 15-17.

Wooden Handle

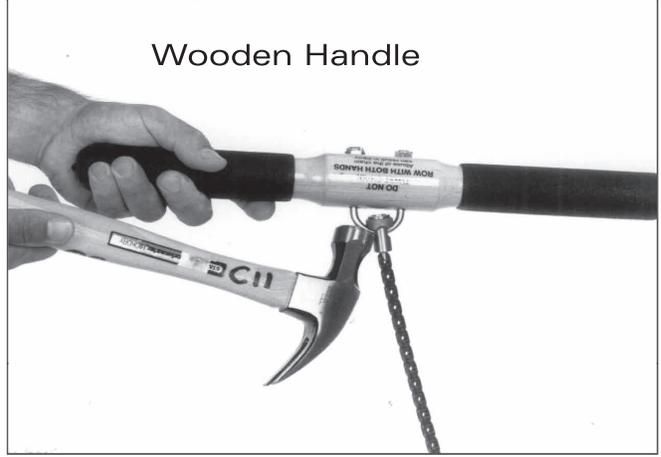

10.

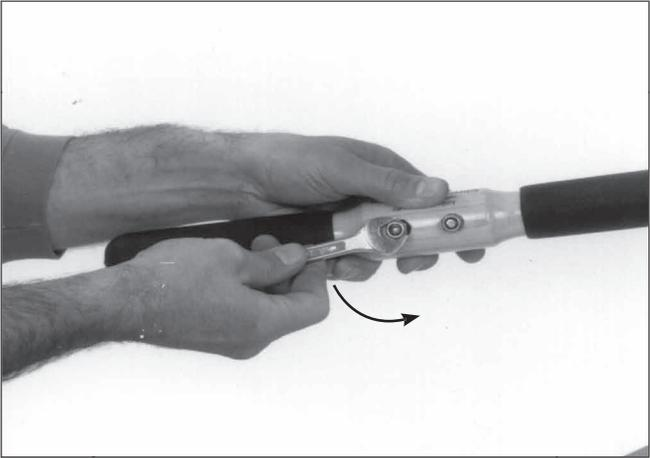

11.

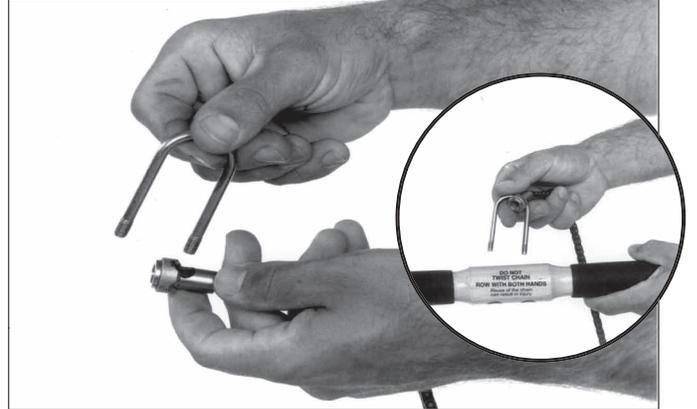

12. Remove old chain and replace with new chain.

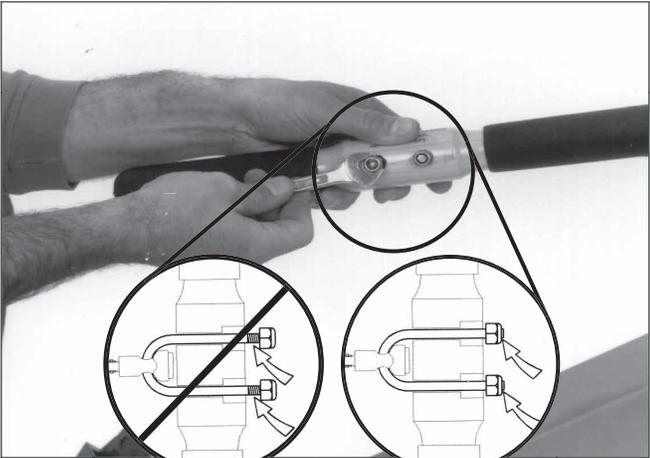

13.



14. Proceed to step 18.

# CHAIN REPLACEMENT - MODEL C,D,E

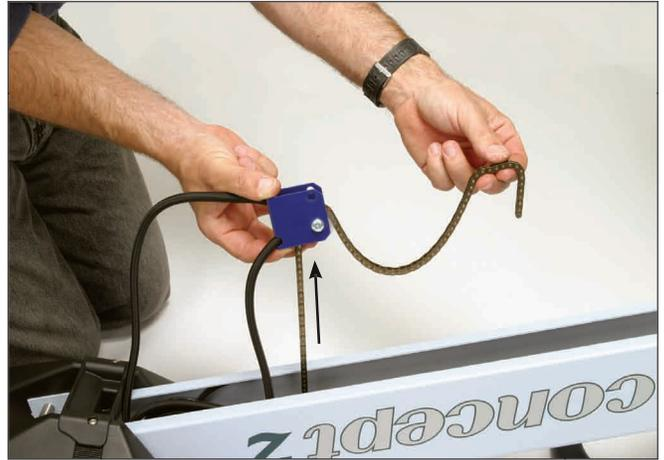
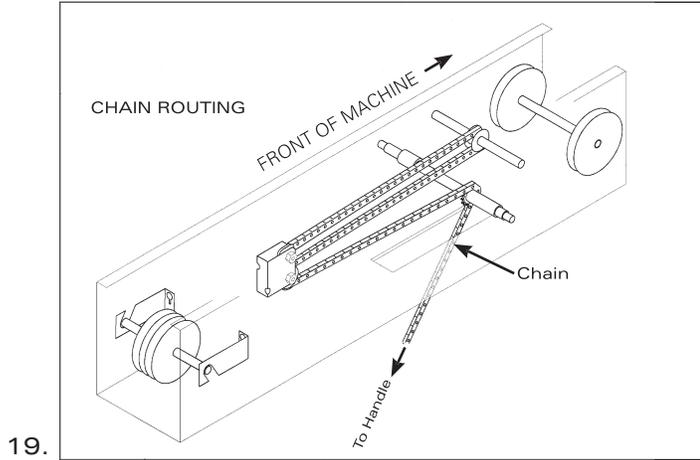

# CHAIN REPLACEMENT - MODEL C,D,E

23.



24.



25.



26.

